

# XP Series Frame Tent Assembly Instructions

## Recommended equipment and manpower for installation:

Two experienced installers can normally install these products in thirty minutes or less.

One or two 4' or 6' step ladders.

Gloves

Approved safety head gear

Ground cover to protect the top

Prior to laying out this or any other ETI product be sure you have thoroughly inspected the area for any overhead or underground obstructions that may interfere with the safe installation of this product.

1. Place the 4 eaves along with the 4 corner weldments in a square configuration on the ground where the frame will be erected.
2. Slide the eaves into weldments locking them into position using the snap buttons creating a ridged perimeter.

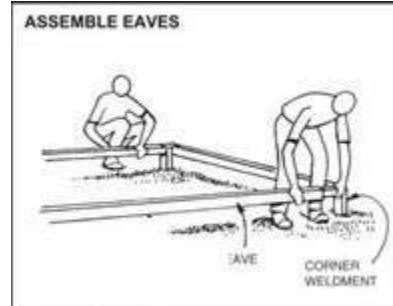

3. Place the first cable diagonally across the frame and slide the loop ends over the steel posts provided at each corner. Making sure the second cable is on the top of the first cable repeat this process. You may have to elevate the corner slightly to attach the last loop.

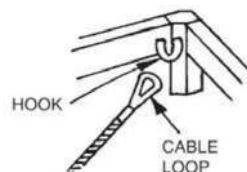
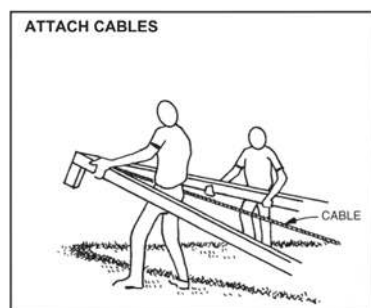

## XP Series Frame Tent Assembly Instructions, continued

- Lay the top over the frame pulling the web loops in the corner over the steel rod to hold the top in place.

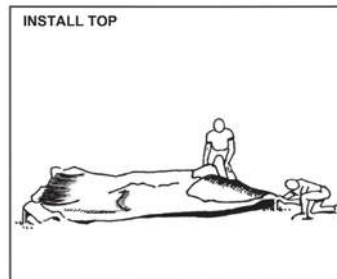

- Raise your first corner and lock the upright into position using the provided snap button in the corner weldment. Stand up leeward side (the side sheltered from the wind) first whenever possible and as you install each upright it is advisable to attach your top tensioning strap and leave in a loose setting. It is also recommended that if there is a wind condition of any kind you put your anchoring system in place and attach the guys to the anchoring system as you erect the frame.

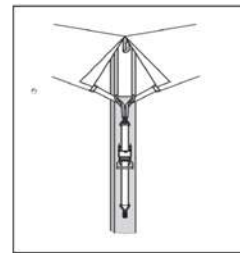
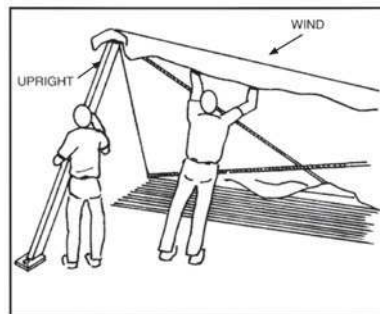

- From underneath the frame go to the low side. Place the center pole pin carefully through the opening provided at the peak of the tent and place the pulley in the center pole base over the top cable. You can now slide the center pole up the cable until it reaches the position where the cables cross. Pull down slightly on the bottom cable locking the base in position. At this point install the wire lock pin through the hole provided at the bottom of the pole base to secure the base to the cables.

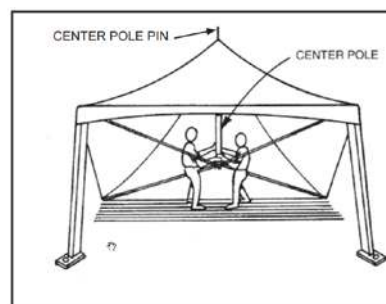

XP Series Frame Tent Assembly Instructions, continued

7. After securing the center pole continue standing up the remaining two corners and attaching the top tensioning straps.

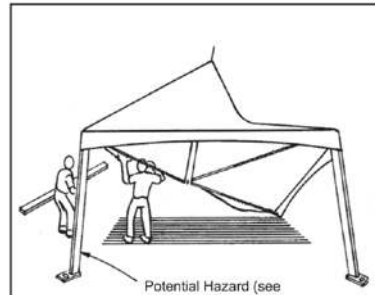

8. While tensioning the top to the frame do not over tighten in any one corner. Make adjustments in the tension so as to keep the top as square and as evenly tensioned as possible.

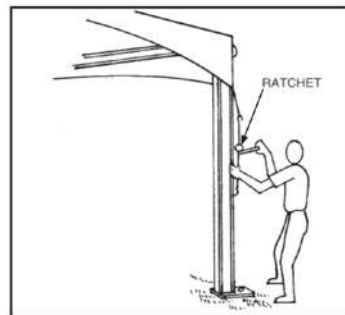

9. You may now attach the strap and buckle to the frame eave if the top has this feature.
10. Please be sure that the frame is securely anchored as well as guyed out for stability.

